



High-Speed Precision *Difet*[®] OPERATIONAL AMPLIFIER

FEATURES

- WIDE BANDWIDTH: 6.5MHz
- HIGH SLEW RATE: 35V/μs
- LOW OFFSET: ±250μV max
- LOW BIAS CURRENT: ±1pA max
- FAST SETTLING TIME: 1μs to 0.01%
- UNITY-GAIN STABLE

DESCRIPTION

The OPA602 is a precision, wide bandwidth FET operational amplifier. Monolithic *Difet* (dielectrically isolated FET) construction provides an unusual combination of high-speed and accuracy.

Its wide-bandwidth design minimizes dynamic errors. High slew rate and fast settling time allow accurate signal processing in pulse and data conversion applications. Wide bandwidth and low distortion minimize AC errors. All specifications are rated with a 1kΩ resistor in parallel with 500pF load. The OPA602 is unity-gain stable and easily drives capacitive loads up to 1500pF.

Laser-trimmed input circuitry provides offset voltage and drift performance normally associated with precision bipolar op amps. *Difet* construction achieves extremely low input bias currents (1pA max) without compromising input voltage noise.

The OPA602's unique input cascode circuitry maintains low input bias current and precise input characteristics over its full input common-mode voltage range.

Difet[®] Burr-Brown Corp.

APPLICATIONS

- PRECISION INSTRUMENTATION
- OPTOELECTRONICS
- SONAR, ULTRASOUND
- PROFESSIONAL AUDIO EQUIPMENT
- MEDICAL EQUIPMENT
- DATA CONVERSION

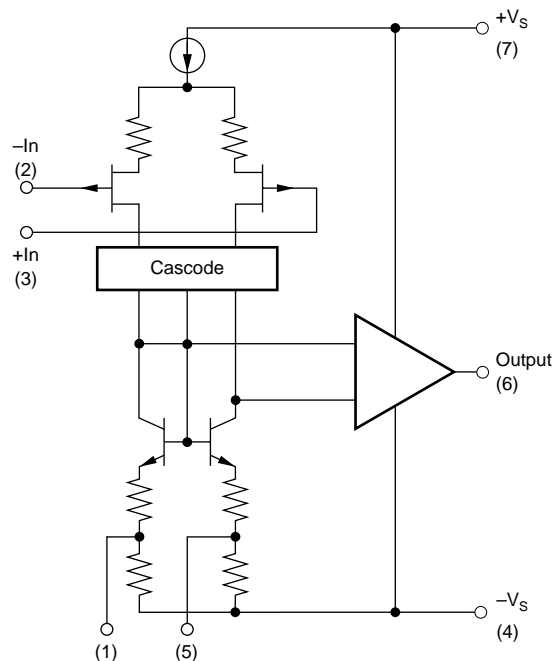

Please be aware that an important notice concerning availability, standard warranty, and use in critical applications of Texas Instruments semiconductor products and disclaimers thereto appears at the end of this data sheet.

ABSOLUTE MAXIMUM RATINGS⁽¹⁾

| | |
|--|---------------------------------|
| Supply Voltage | $\pm 18V_{DC}$ |
| Internal Power Dissipation ($T_J \leq +175^\circ C$) | 1000mW |
| Differential Input Voltage | Total V_S |
| Input Voltage Range | $\pm V_S$ |
| Storage Temperature Range | |
| P and U Packages | $-40^\circ C$ to $+125^\circ C$ |
| Operating Temperature Range | |
| P and U Packages | $-25^\circ C$ to $+85^\circ C$ |
| Lead Temperature | |
| U Package, SO (3s) | $+260^\circ C$ |
| Output Short-Circuit to Ground ($+25^\circ C$) | Continuous |
| Junction Temperature | $+175^\circ C$ |

NOTE: (1) Stresses above those listed under "Absolute Maximum Ratings" may cause permanent damage to the device. Exposure to absolute maximum conditions for extended periods may affect device reliability.



ELECTROSTATIC DISCHARGE SENSITIVITY

This integrated circuit can be damaged by ESD. Texas Instruments recommends that all integrated circuits be handled with appropriate precautions. Failure to observe proper handling and installation procedures can cause damage.

ESD damage can range from subtle performance degradation to complete device failure. Precision integrated circuits may be more susceptible to damage because very small parametric changes could cause the device not to meet its published specifications.

PACKAGE/ORDERING INFORMATION

| PRODUCT | OFFSET VOLTAGE MAX (μV) AT $25^\circ C$ | PACKAGE-LEAD | PACKAGE DESIGNATOR ⁽¹⁾ | SPECIFIED TEMPERATURE RANGE | PACKAGE MARKING | ORDERING NUMBER | TRANSPORT MEDIA, QUANTITY |
|----------|--|--------------|-----------------------------------|--------------------------------|-----------------|-----------------|---------------------------|
| OPA602AP | ± 2000 | DIP-8 | P | $-25^\circ C$ to $+85^\circ C$ | 602AP | 602AP | Tubes, 50 |
| OPA602BP | ± 1000 | " | " | " | 602BP | 602BP | Tubes, 50 |
| OPA602AU | ± 3000 | SO-8 | D | $-25^\circ C$ to $+85^\circ C$ | 602AU | 602AU | Tubes, 100 |

NOTE: (1) For the most current specifications and package information, refer to our web site at www.ti.com.

PIN CONFIGURATIONS

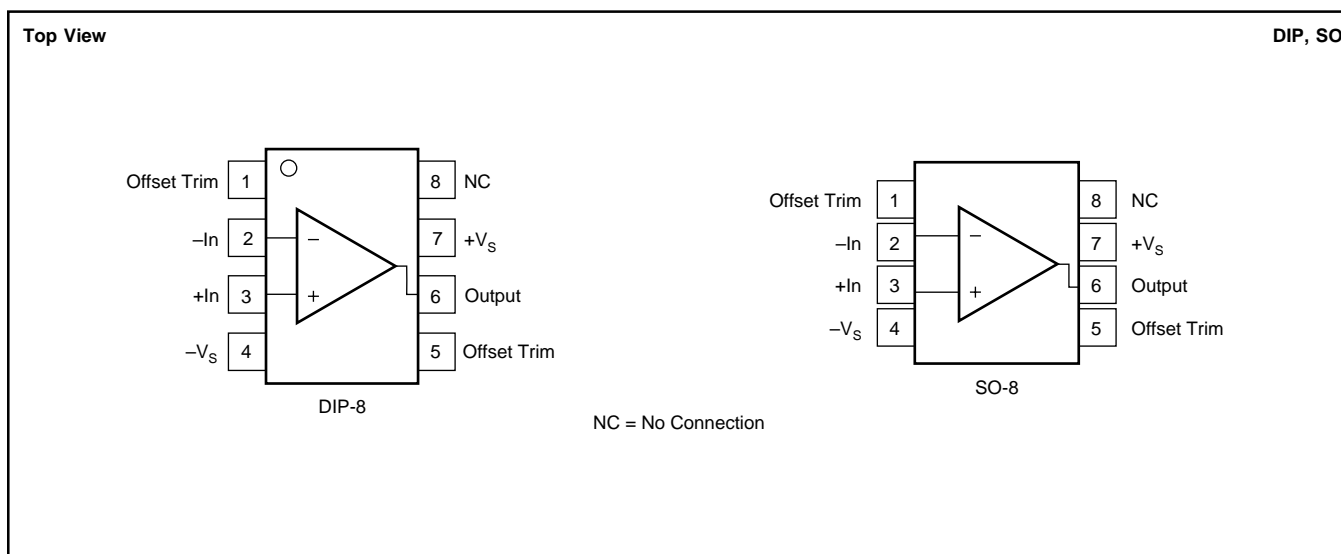

ELECTRICAL CHARACTERISTICS

At $V_S = \pm 15V_{DC}$ and $T_A = +25^\circ C$, unless otherwise noted.

| PARAMETER | CONDITIONS | OPA602BP | | | OPA602AP, AU | | | UNITS |
|---|--|---|--|----------------------|--------------|---------------------|------------------------|--|
| | | MIN | TYP | MAX | MIN | TYP | MAX | |
| INPUT NOISE Voltage: $f_O = 10\text{Hz}$ $f_O = 100\text{Hz}$ $f_O = 1\text{kHz}$ $f_O = 10\text{kHz}$ $f_B = 10\text{Hz to } 10\text{kHz}$ $f_B = 0.1\text{Hz to } 10\text{Hz}$ Current: $f_B = 0.1\text{Hz to } 10\text{Hz}$ $f_O = 0.1\text{Hz to } 20\text{kHz}$ | | | 23 | | | * | | $\text{nV}/\sqrt{\text{Hz}}$ |
| | | | | 19 | | | * | $\text{nV}/\sqrt{\text{Hz}}$ |
| | | | | 13 | | | * | $\text{nV}/\sqrt{\text{Hz}}$ |
| | | | | 12 | | | * | $\text{nV}/\sqrt{\text{Hz}}$ |
| | | | | 1.4 | | | * | μVrms |
| | | | | 0.95 | | | * | $\mu\text{Vp-p}$ |
| | | | | 12 | | | * | fAp-p |
| | | | 0.6 | | | * | fA/ $\sqrt{\text{Hz}}$ | |
| OFFSET VOLTAGE Input Offset Voltage: P Package U Package Over Specified Temperature P, U Packages Average Drift ⁽¹⁾ Supply Rejection | | | 0.5 | 1 | | 1 1 | 2 3 | mV mV |
| | | | ± 0.75 | ± 1.5 | | ± 1.5 | | mV |
| | | $T_A = T_{\text{MIN}} \text{ to } T_{\text{MAX}}$ | ± 3 | ± 5 | | * | ± 15 | $\mu\text{V}/^\circ\text{C}$ |
| | | $\pm V_S = 12\text{V to } 18\text{V}$ | 80 | 100 | 70 | * | | dB |
| BIAS CURRENT Input Bias Current Over Specified Temperature | $V_{\text{CM}} = 0V_{\text{DC}}$ | | ± 1 ± 20 | ± 2 ± 200 | | ± 2 ± 20 | ± 10 ± 500 | pA pA |
| | | | 0.5 20 | 2 200 | | 1 20 | 10 500 | pA pA |
| OFFSET CURRENT Input Offset Current Over Specified Temperature | $V_{\text{CM}} = 0V_{\text{DC}}$ | | 0.5 20 | 2 200 | | 1 20 | 10 500 | pA pA |
| | | | | | | | | |
| INPUT IMPEDANCE Differential Common-Mode | | | $10^{13} \parallel 1$ $10^{14} \parallel 3$ | | | * | | $\Omega \parallel \text{pF}$ $\Omega \parallel \text{pF}$ |
| | | | | | | | | |
| INPUT VOLTAGE RANGE Common-Mode Input Range Common-Mode Rejection | | ± 10.2 88 | +13, -11 100 | | * | * | | V dB |
| | $V_{\text{IN}} = \pm 10V_{\text{DC}}$ | | | | 75 | * | | |
| OPEN-LOOP GAIN, DC Open-Loop Voltage Gain | $R_L \geq 1\text{k}\Omega$ | 88 | 100 | | 75 | * | | dB |
| | | | | | | | | |
| FREQUENCY RESPONSE Gain Bandwidth Full-Power Response Slew Rate Settling Time: 0.1% 0.01% | Gain = 100 20Vp-p, $R_L = 1\text{k}\Omega$ | 4 | 6.5 570 | | 3.5 | * | | MHz kHz |
| | $V_O = \pm 10\text{V}$, $R_L = 1\text{k}\Omega$ | 24 | 35 | | 20 | * | | V/ μs |
| | Gain = -1, $R_L = 1\text{k}\Omega$ | | 0.6 | | | * | | μs |
| | $C_L = 500\text{pF}$, 10V Step | | 1.0 | | | | | μs |
| | | | | | | | | |
| RATED OUTPUT Voltage Output Current Output Output Resistance Load Capacitance Stability Short-Circuit Current | $R_L = 1\text{k}\Omega$ | ± 11.5 | +12.9, -13.8 | | ± 11 | * | | V |
| | $V_O = \pm 10V_{\text{DC}}$ | ± 15 | ± 20 | | * | * | | mA |
| | 1MHz, Open Loop | | 80 | | * | * | | Ω |
| | Gain = +1 | | 1500 | | * | * | | pF |
| | | ± 30 | ± 50 | | ± 25 | * | | mA |
| POWER SUPPLY Rated Voltage Voltage Range, Derated Performance Current, Quiescent Over Specified Temperature | | ± 5 | ± 15 | ± 18 | * | * | * | V_{DC} V_{DC} |
| | $I_O = 0\text{mADC}$ | | 3 | 4 | | * | * | mA |
| | | | 3.5 | 4.5 | | * | * | mA |
| | | | | | | | | |
| TEMPERATURE RANGE Specification Operating: P, U Packages Storage: P, U Packages θ_{JA} | Ambient Temperature | -25 | | +85 | * | | * | $^\circ\text{C}$ |
| | | -25 | | +85 | * | | * | $^\circ\text{C}$ |
| | | -40 | | +125 | * | | * | $^\circ\text{C}$ |
| | | 200 | | | * | | * | $^\circ\text{C/W}$ |
| | | | | | | | | |

* Same specifications as OPA602BP.

NOTE: (1) OPA602AP, AU ensured by design with a 99% confidence level.

TYPICAL CHARACTERISTICS

At $T_A = +25^\circ\text{C}$ and $V_S = \pm 15\text{V}_{\text{DC}}$, unless otherwise noted.

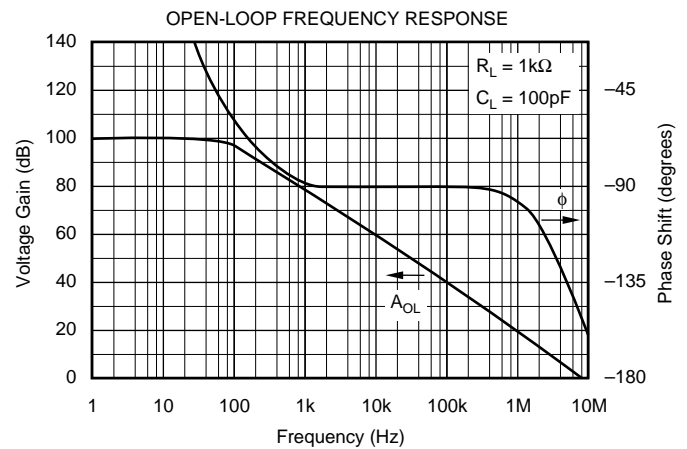
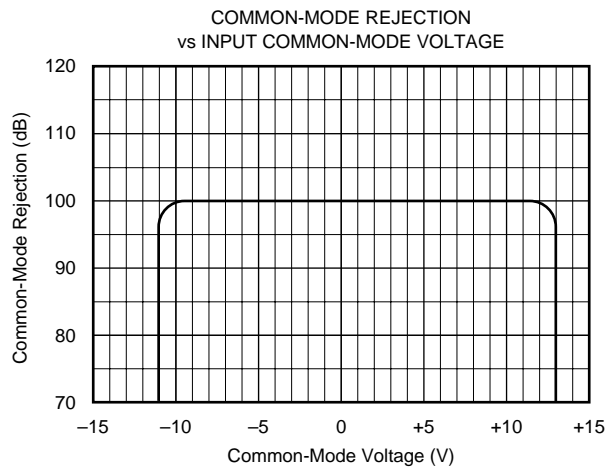
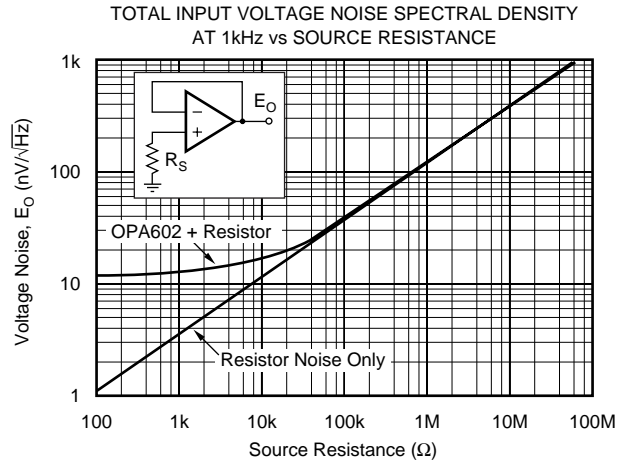
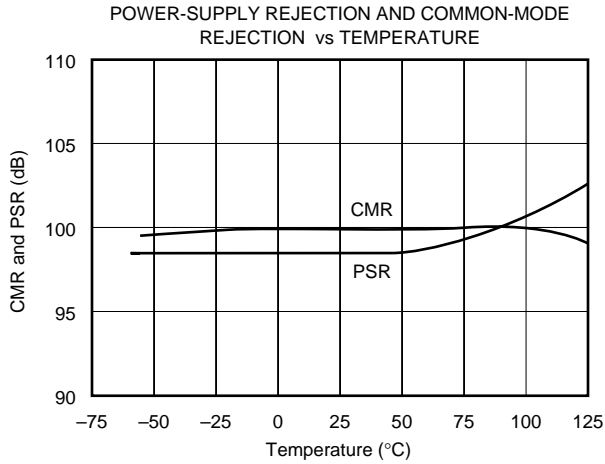
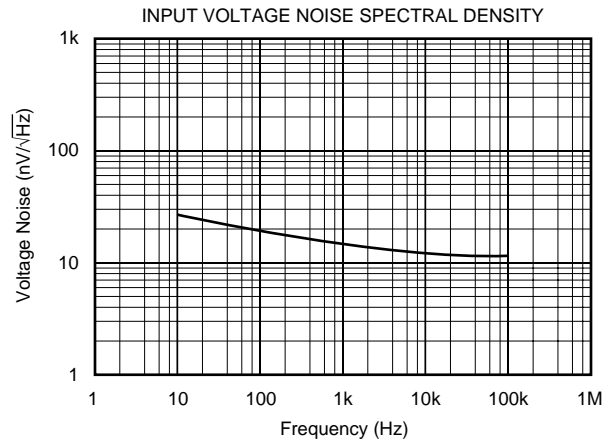
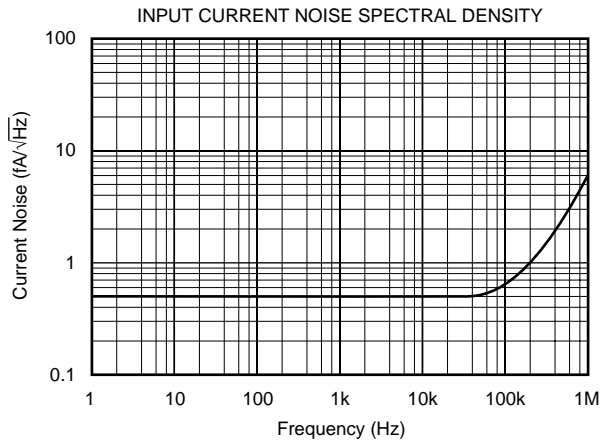

TYPICAL CHARACTERISTICS (Cont.)

At $T_A = +25^\circ\text{C}$ and $V_S = \pm 15\text{V}_{\text{DC}}$, unless otherwise noted.

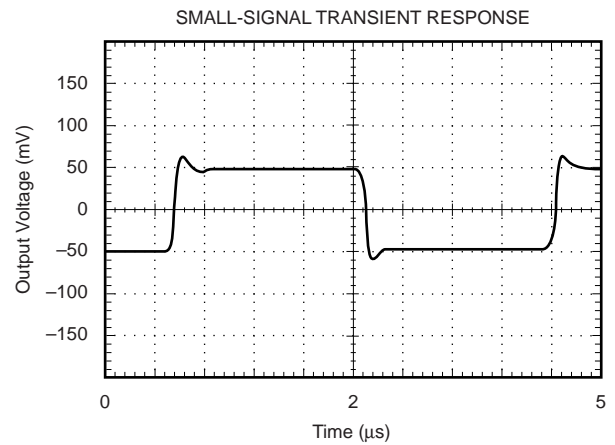
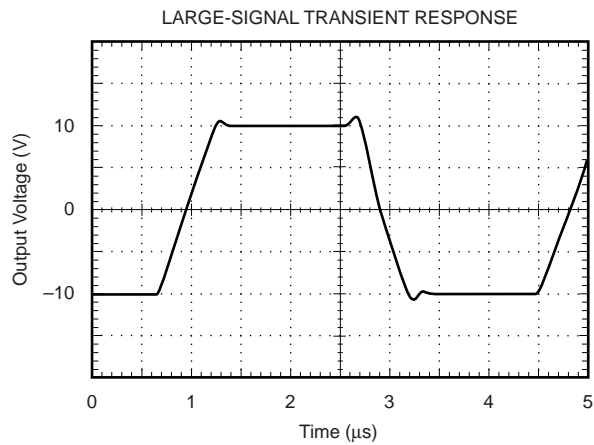
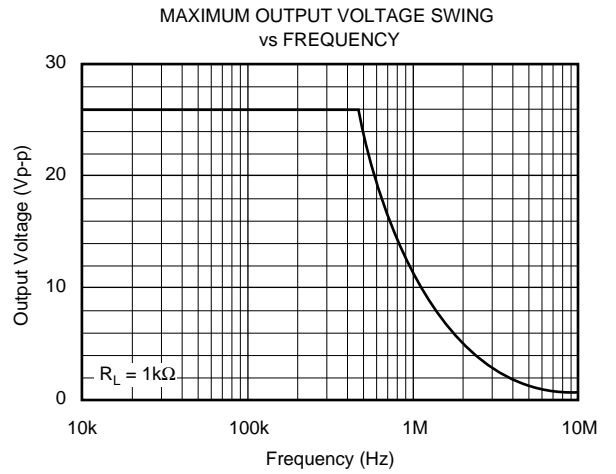
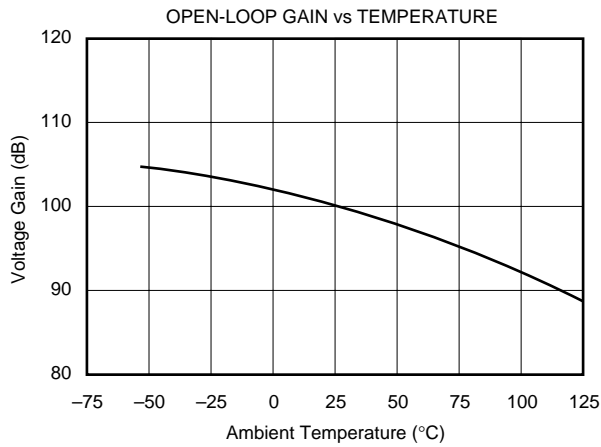
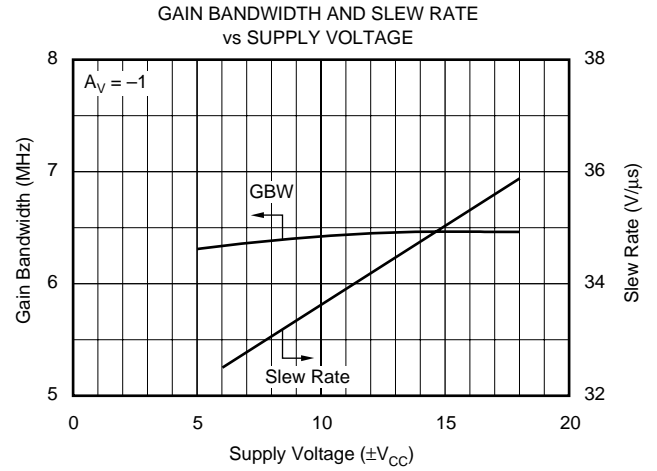
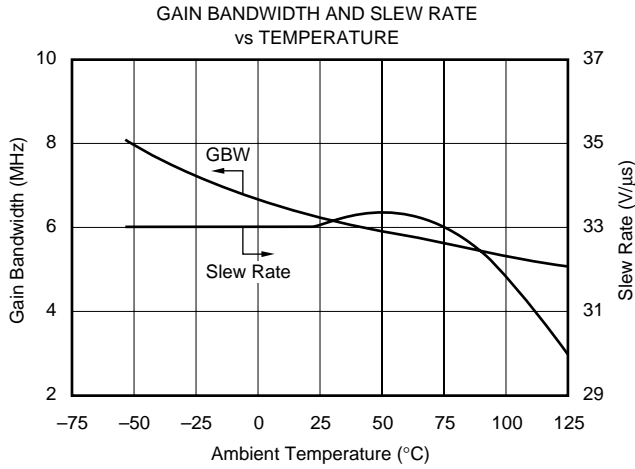

TYPICAL CHARACTERISTICS (Cont.)

At $T_A = +25^\circ\text{C}$ and $V_S = \pm 15\text{V}_{\text{DC}}$, unless otherwise noted.

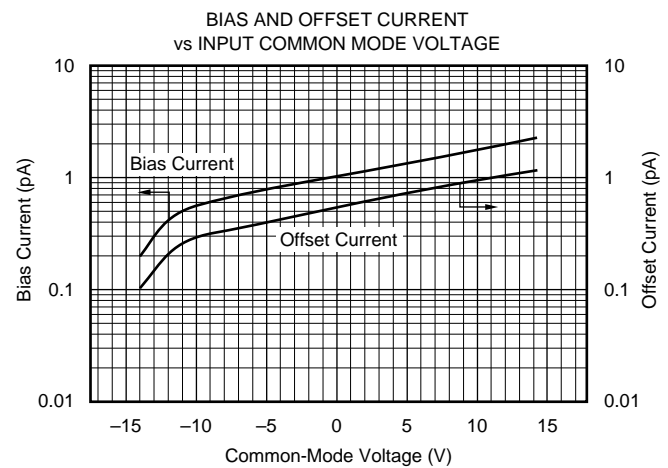
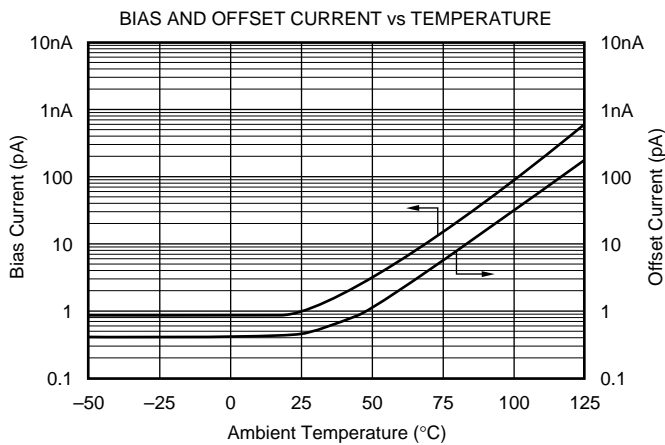
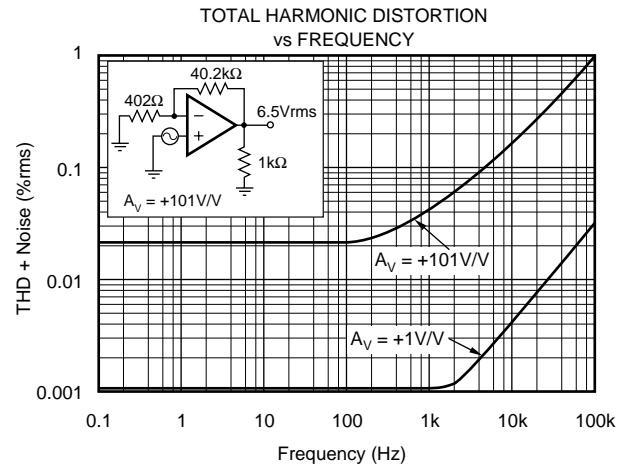
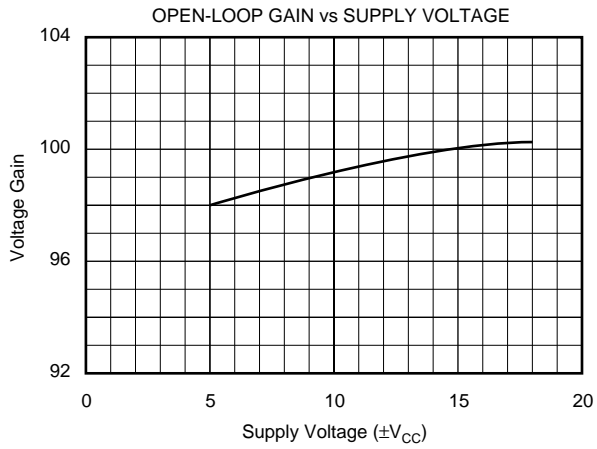
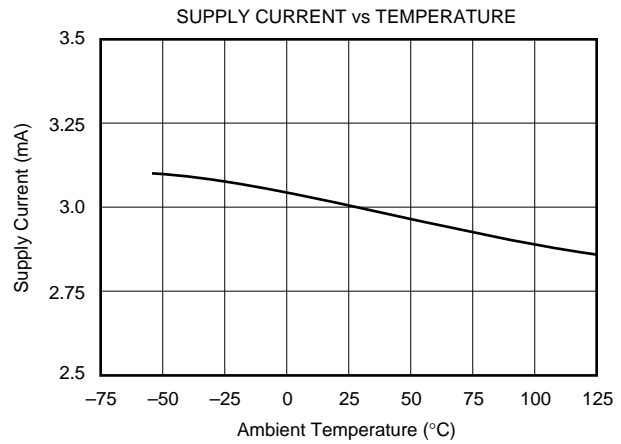
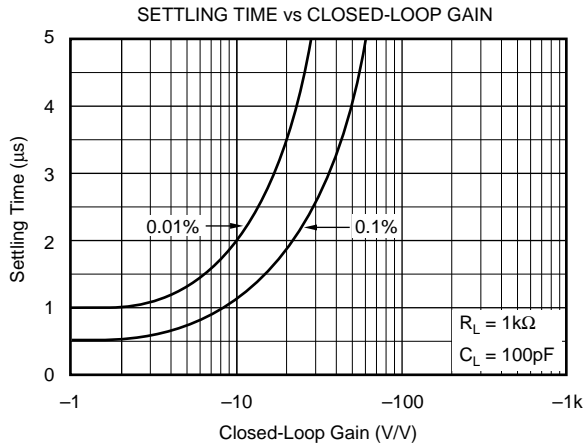

TYPICAL CHARACTERISTICS (Cont.)

At $T_A = +25^\circ\text{C}$ and $V_S = \pm 15\text{V}_{\text{DC}}$, unless otherwise noted.

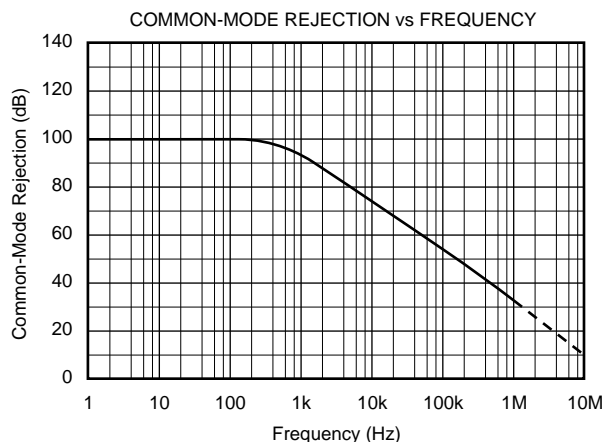
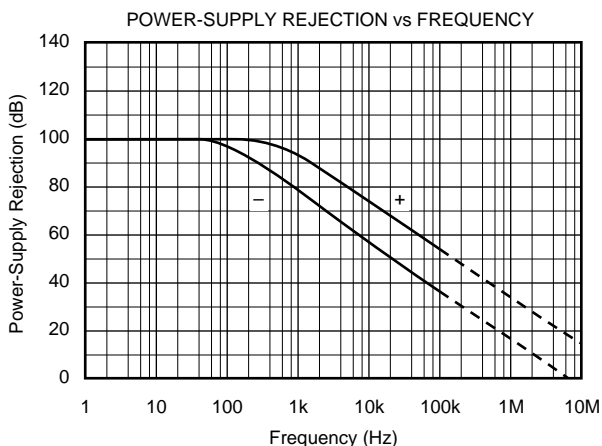

APPLICATIONS INFORMATION

Unity-gain stability with good phase margin and excellent output drive characteristics bring freedom from the subtle problems associated with other high-speed amplifiers. However, as with any high-speed, wide bandwidth circuitry, careful circuit layout will ensure best performance. Make short, direct interconnections and avoid stray wiring capacitance—especially at the inverting input pin.

Power supplies should be bypassed with good high-frequency capacitors positioned close to the op amp pins. In most cases $0.1\mu\text{F}$ ceramic capacitors are adequate. Applications with heavier loads and fast transient waveforms may benefit from use of additional $1.0\mu\text{F}$ tantalum bypass capacitors.

INPUT BIAS CURRENT GUARDING

Leakage currents across printed circuit boards can easily exceed the input bias current of the OPA602. A circuit board “guard” pattern, as shown in Figure 1, is an effective solution to difficult leakage problems. This guard pattern must be repeated on all layers of a multilayer board. By surrounding critical high impedance input circuitry with a low impedance circuit connection at the same potential, leakage currents will flow harmlessly to the low-impedance node.

Input bias current may also be degraded by improper handling or cleaning. Contamination from handling parts and circuit boards may be cleaned with appropriate solvents and deionized water. Each rinsing operation should be followed by a 30-minute bake at $+85^\circ\text{C}$.

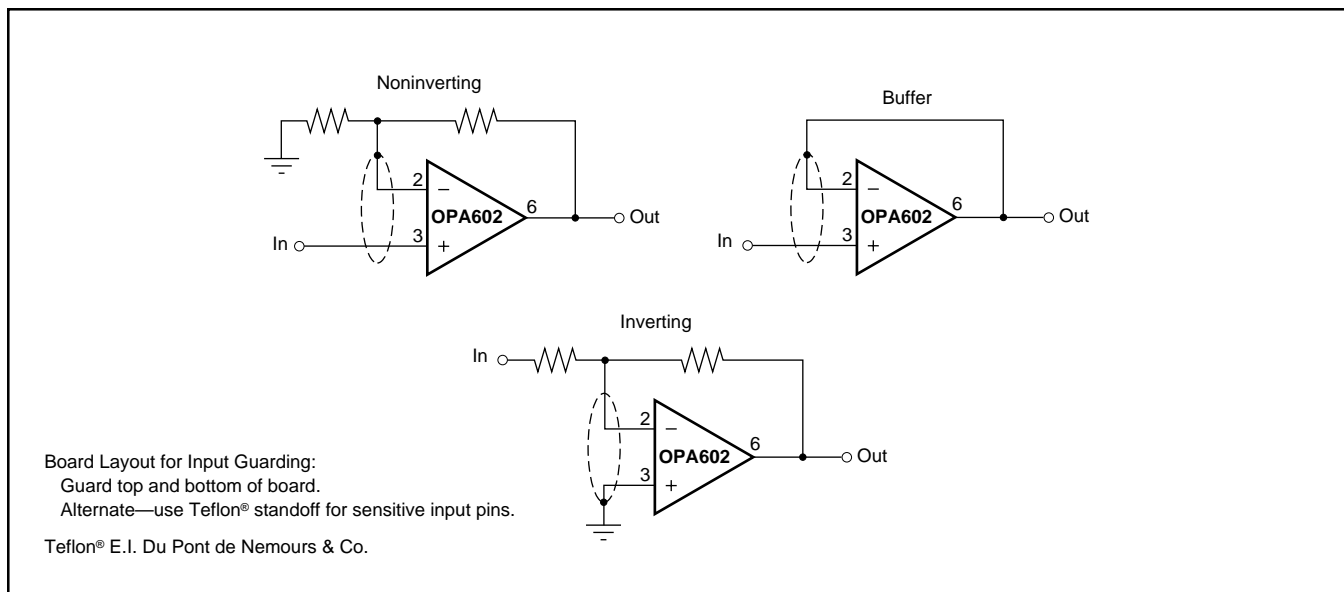

FIGURE 1. Connection of Input Guard.

APPLICATION CIRCUITS

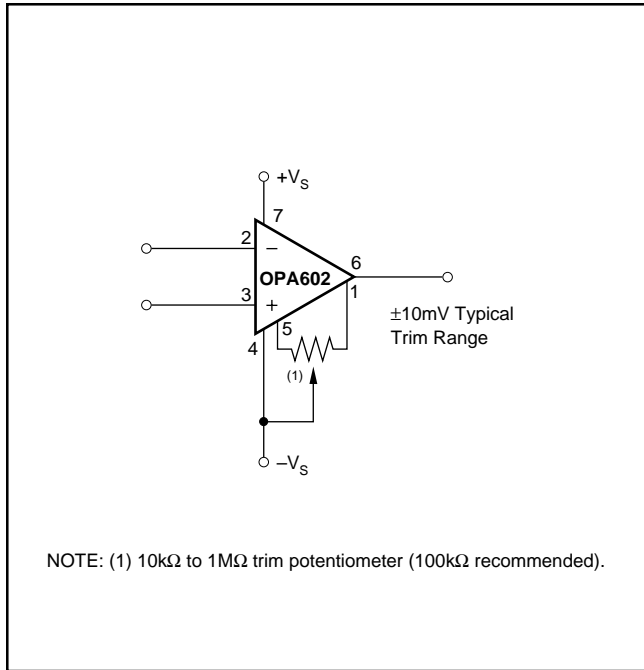

FIGURE 2. Offset Voltage Trim.

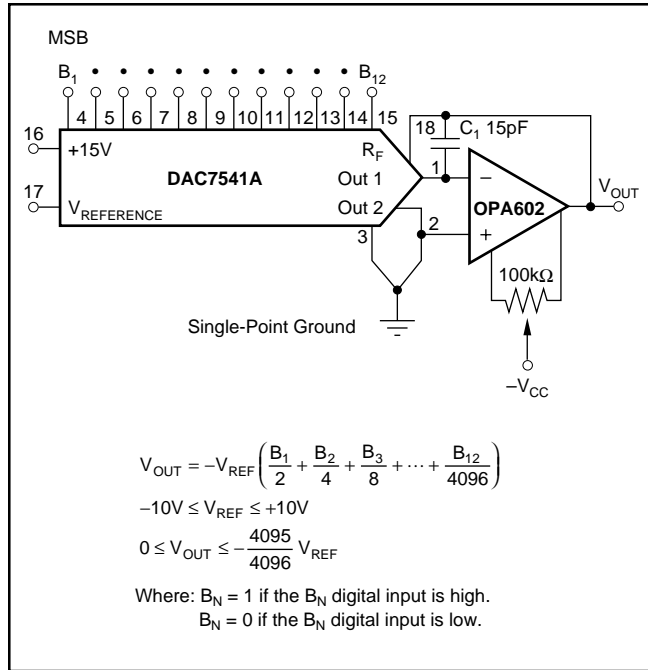

FIGURE 3. Voltage Output Digital-to-Analog Converter.

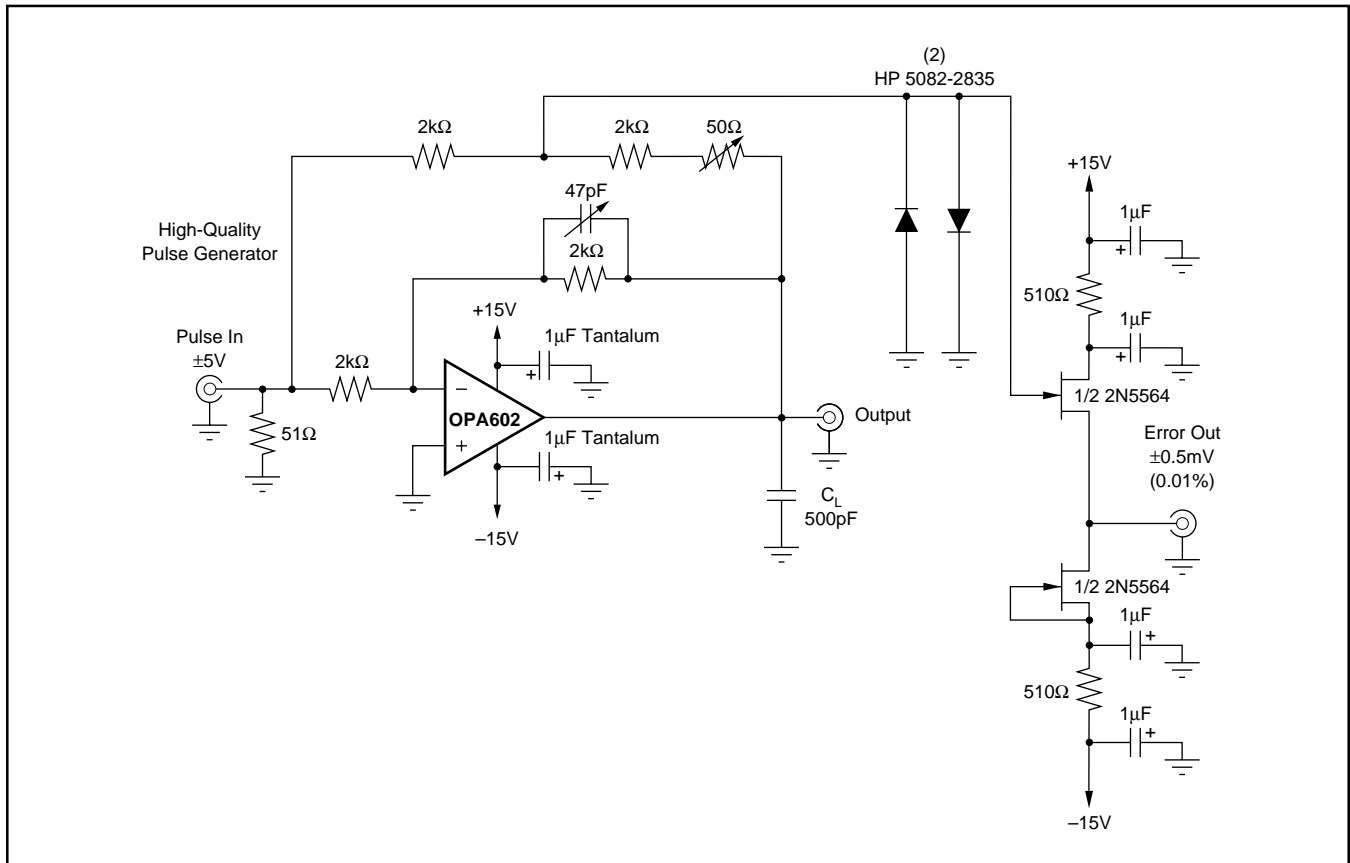
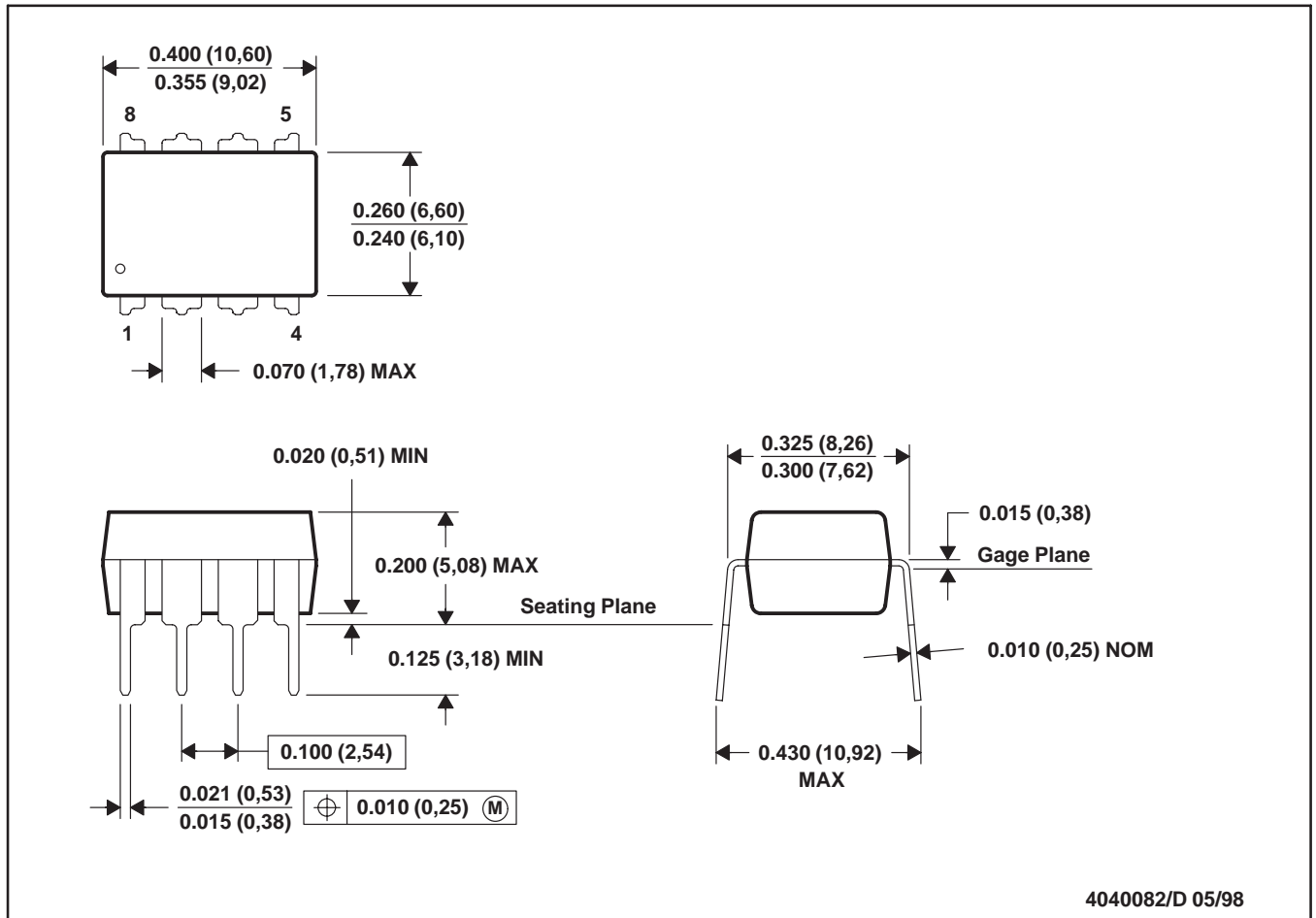

FIGURE 4. Settling Time and Slew Rate Test Circuit.



- NOTES: A. All linear dimensions are in inches (millimeters).
 B. This drawing is subject to change without notice.
 C. Falls within JEDEC MS-001

D (R-PDSO-G**)

PLASTIC SMALL-OUTLINE PACKAGE

8 PINS SHOWN

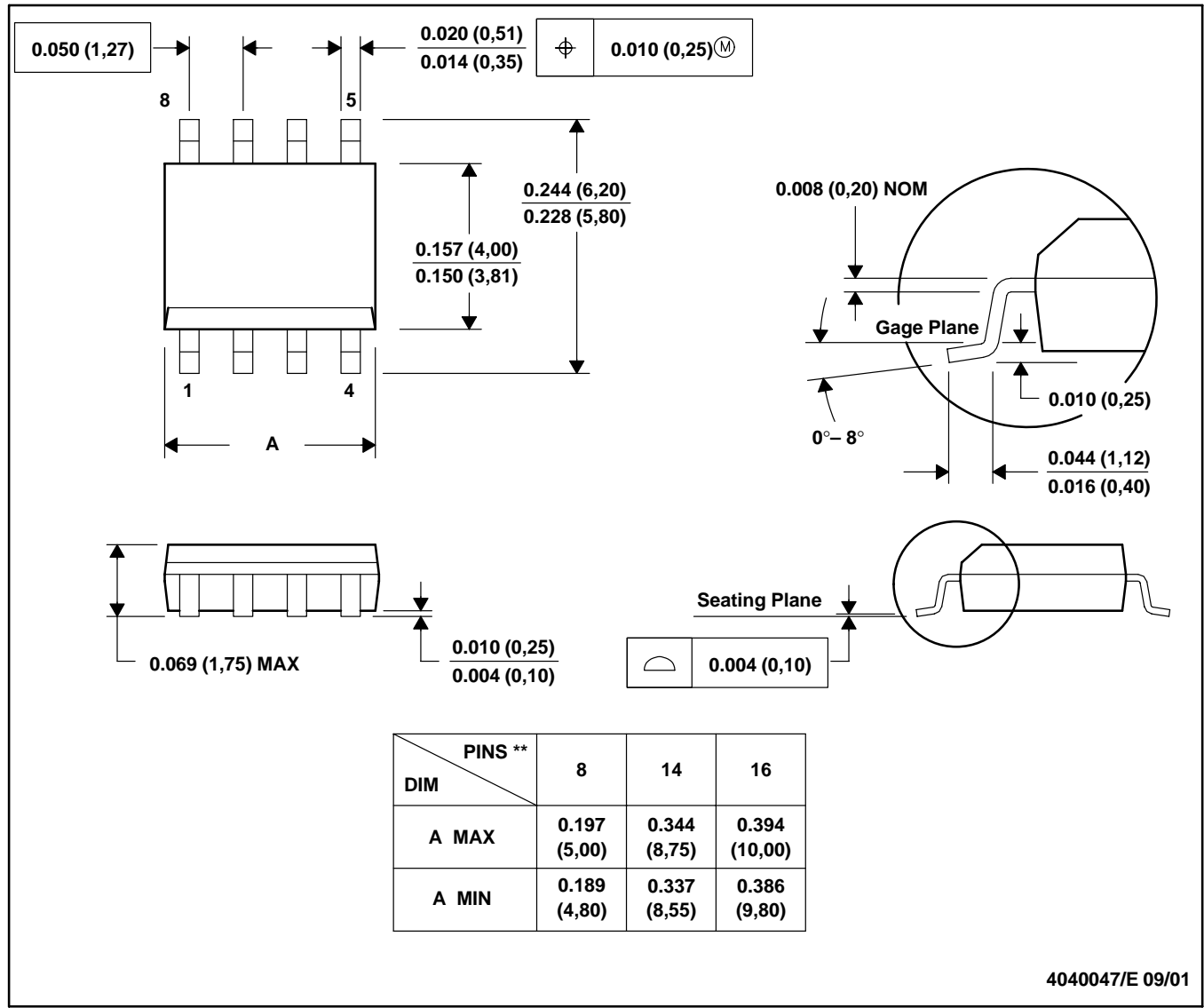

- NOTES: A. All linear dimensions are in inches (millimeters).
 B. This drawing is subject to change without notice.
 C. Body dimensions do not include mold flash or protrusion, not to exceed 0.006 (0,15).
 D. Falls within JEDEC MS-012

PACKAGING INFORMATION

| Orderable Device | Status ⁽¹⁾ | Package Type | Package Drawing | Pins | Package Qty | Eco Plan ⁽²⁾ | Lead/Ball Finish | MSL Peak Temp ⁽³⁾ |
|------------------|-----------------------|--------------|-----------------|------|-------------|-------------------------|------------------|------------------------------|
| OPA602AM | OBSOLETE | TO-99 | LMC | 8 | | TBD | Call TI | Call TI |
| OPA602AM2 | OBSOLETE | TO-99 | LMC | 8 | | TBD | Call TI | Call TI |
| OPA602AP | ACTIVE | PDIP | P | 8 | 50 | TBD | Call TI | Level-NA-NA-NA |
| OPA602AU | ACTIVE | SOIC | D | 8 | 100 | TBD | CU SNPB | Level-2-220C-1 YEAR |
| OPA602AU/2K5 | ACTIVE | SOIC | D | 8 | 2500 | TBD | CU SNPB | Level-2-220C-1 YEAR |
| OPA602BM | OBSOLETE | TO-99 | LMC | 8 | | TBD | Call TI | Call TI |
| OPA602BM1 | OBSOLETE | TO-99 | LMC | 8 | | TBD | Call TI | Call TI |
| OPA602BP | ACTIVE | PDIP | P | 8 | 50 | TBD | Call TI | Level-NA-NA-NA |
| OPA602CM | OBSOLETE | TO-99 | LMC | 8 | | TBD | Call TI | Call TI |
| OPA602SM | OBSOLETE | TO-99 | LMC | 8 | | TBD | Call TI | Call TI |

⁽¹⁾ The marketing status values are defined as follows:

ACTIVE: Product device recommended for new designs.

LIFEBUY: TI has announced that the device will be discontinued, and a lifetime-buy period is in effect.

NRND: Not recommended for new designs. Device is in production to support existing customers, but TI does not recommend using this part in a new design.

PREVIEW: Device has been announced but is not in production. Samples may or may not be available.

OBSOLETE: TI has discontinued the production of the device.

⁽²⁾ Eco Plan - The planned eco-friendly classification: Pb-Free (RoHS) or Green (RoHS & no Sb/Br) - please check <http://www.ti.com/productcontent> for the latest availability information and additional product content details.

TBD: The Pb-Free/Green conversion plan has not been defined.

Pb-Free (RoHS): TI's terms "Lead-Free" or "Pb-Free" mean semiconductor products that are compatible with the current RoHS requirements for all 6 substances, including the requirement that lead not exceed 0.1% by weight in homogeneous materials. Where designed to be soldered at high temperatures, TI Pb-Free products are suitable for use in specified lead-free processes.

Green (RoHS & no Sb/Br): TI defines "Green" to mean Pb-Free (RoHS compatible), and free of Bromine (Br) and Antimony (Sb) based flame retardants (Br or Sb do not exceed 0.1% by weight in homogeneous material)

⁽³⁾ MSL, Peak Temp. -- The Moisture Sensitivity Level rating according to the JEDEC industry standard classifications, and peak solder temperature.

Important Information and Disclaimer:The information provided on this page represents TI's knowledge and belief as of the date that it is provided. TI bases its knowledge and belief on information provided by third parties, and makes no representation or warranty as to the accuracy of such information. Efforts are underway to better integrate information from third parties. TI has taken and continues to take reasonable steps to provide representative and accurate information but may not have conducted destructive testing or chemical analysis on incoming materials and chemicals. TI and TI suppliers consider certain information to be proprietary, and thus CAS numbers and other limited information may not be available for release.

In no event shall TI's liability arising out of such information exceed the total purchase price of the TI part(s) at issue in this document sold by TI to Customer on an annual basis.

IMPORTANT NOTICE

Texas Instruments Incorporated and its subsidiaries (TI) reserve the right to make corrections, modifications, enhancements, improvements, and other changes to its products and services at any time and to discontinue any product or service without notice. Customers should obtain the latest relevant information before placing orders and should verify that such information is current and complete. All products are sold subject to TI's terms and conditions of sale supplied at the time of order acknowledgment.

TI warrants performance of its hardware products to the specifications applicable at the time of sale in accordance with TI's standard warranty. Testing and other quality control techniques are used to the extent TI deems necessary to support this warranty. Except where mandated by government requirements, testing of all parameters of each product is not necessarily performed.

TI assumes no liability for applications assistance or customer product design. Customers are responsible for their products and applications using TI components. To minimize the risks associated with customer products and applications, customers should provide adequate design and operating safeguards.

TI does not warrant or represent that any license, either express or implied, is granted under any TI patent right, copyright, mask work right, or other TI intellectual property right relating to any combination, machine, or process in which TI products or services are used. Information published by TI regarding third-party products or services does not constitute a license from TI to use such products or services or a warranty or endorsement thereof. Use of such information may require a license from a third party under the patents or other intellectual property of the third party, or a license from TI under the patents or other intellectual property of TI.

Reproduction of information in TI data books or data sheets is permissible only if reproduction is without alteration and is accompanied by all associated warranties, conditions, limitations, and notices. Reproduction of this information with alteration is an unfair and deceptive business practice. TI is not responsible or liable for such altered documentation.

Resale of TI products or services with statements different from or beyond the parameters stated by TI for that product or service voids all express and any implied warranties for the associated TI product or service and is an unfair and deceptive business practice. TI is not responsible or liable for any such statements.

Following are URLs where you can obtain information on other Texas Instruments products and application solutions:

| Products | | Applications | |
|------------------|--|---------------------|--|
| Amplifiers | amplifier.ti.com | Audio | www.ti.com/audio |
| Data Converters | dataconverter.ti.com | Automotive | www.ti.com/automotive |
| DSP | dsp.ti.com | Broadband | www.ti.com/broadband |
| Interface | interface.ti.com | Digital Control | www.ti.com/digitalcontrol |
| Logic | logic.ti.com | Military | www.ti.com/military |
| Power Mgmt | power.ti.com | Optical Networking | www.ti.com/opticalnetwork |
| Microcontrollers | microcontroller.ti.com | Security | www.ti.com/security |
| | | Telephony | www.ti.com/telephony |
| | | Video & Imaging | www.ti.com/video |
| | | Wireless | www.ti.com/wireless |

Mailing Address: Texas Instruments
Post Office Box 655303 Dallas, Texas 75265