

EITEL-McCULLOUGH, INC.

SAN BRUNO, CALIFORNIA

304TL

LOW-MU TRIODE
MODULATOR
OSCILLATOR
AMPLIFIER

The Eimac 304TL is a low-mu, power triode having a maximum plate dissipation rating of 300 watts, and is intended for use as an amplifier, oscillator or modulator, where maximum performance can be obtained at low plate voltage. It can be used at its maximum ratings at frequencies as high as 40-Mc.
Cooling of the 304TL is accomplished by radiation from the plate, which operates at a visible red color at maximum dissipation, and by means of air convection around the envelope.

GENERAL CHARACTERISTICS

ELECTRICAL

Filament: Thoriated tungsten	
Voltage	5.0 or 10.0 volts
Current	25.0 or 12.5 amperes
Amplification Factor (Average)	12
▶ Direct Interelectrode Capacitances (Average)	
Grid-Plate	8.6 $\mu\mu\text{f}$
Grid-Filament	12.1 $\mu\mu\text{f}$
Plate-Filament	.8 $\mu\mu\text{f}$
▶ Transconductance ($i_b = 1.0$ amp., $E_b = 3000$ v., $e_c = -175$ v.)	16,700 μmhos
Frequency for Maximum Ratings	40 Mc.

MECHANICAL

Base	Special 4 pin, No. 5000B
Basing	RMA type 48C
▶ Mounting	Vertical, base down or up
▶ Cooling	Convection and Radiation
▶ Recommended Heat Dissipating Connectors:	
Plate	HR-7
Grid	HR-6
Maximum Overall Dimensions:	
Length	7.625 inches
Diameter	3.563 inches
▶ Net weight	9 ounces
▶ Shipping weight (Average)	2 pounds

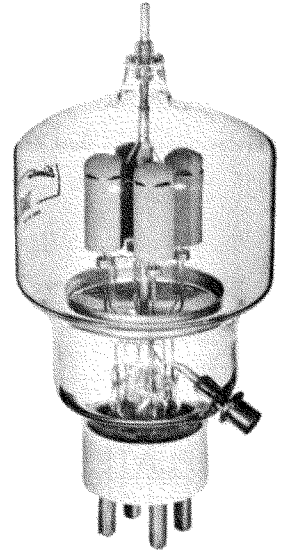

AUDIO FREQUENCY POWER AMPLIFIER AND MODULATOR

Class B (Sinusoidal wave, two tubes unless otherwise specified)

MAXIMUM RATINGS

D-C PLATE VOLTAGE	3000 MAX. VOLTS
MAX-SIGNAL D-C PLATE CURRENT, PER TUBE	900 MAX. MA.
PLATE DISSIPATION, PER TUBE	300 MAX. WATTS

▶ TYPICAL OPERATION, CLASS AB₂

D-C Plate Voltage	1500	2000	2500	3000	Volts
D-C Grid Voltage (approx.)*	-118	-170	-230	-290	Volts
Zero-Signal D-C Plate Current	270	200	160	130	Ma.
Max-Signal D-C Plate Current	572	546	483	444	Ma.
Effective Load, Plate-to-Plate	2540	5300	8500	12,000	Ohms
Peak A-F Grid Input Voltage (per tube)	118	170	230	290	Volts
Max-Signal Peak Driving Power	0	0	0	0	Watts
Max-Signal Plate Power Output	256	490	610	730	Watts

*Adjust to give stated zero-signal plate current. The effective grid circuit resistance for each tube must not exceed 250,000 ohms.

▶ TYPICAL OPERATION, CLASS AB₂

D-C Plate Voltage	1500	2000	2500	3000	Volts
D-C Grid Voltage (approx.)*	-118	-170	-230	-290	Volts
Zero-Signal D-C Plate Current	270	200	160	130	Ma.
Max-Signal D-C Plate Current	1140	1000	900	800	Ma.
Effective Load, Plate-to-Plate	2750	4500	6600	9100	Ohms
Peak A-F Grid Input Voltage (per tube)	245	290	340	390	Volts
Max-Signal Peak Driving Power	78	87	95	110	Watts
Max-Signal Nominal Driving Power (approx.)	39	44	48	55	Watts
Max-Signal Plate Power Output	1100	1400	1650	1800	Watts

*Adjust to give stated zero-signal plate current.

▶ PLATE MODULATED RADIO FREQUENCY AMPLIFIER

Class-C Telephony (Carrier conditions, per tube)

MAXIMUM RATINGS

D-C PLATE VOLTAGE	2500 MAX. VOLTS
D-C PLATE CURRENT	700 MAX. MA.
PLATE DISSIPATION	200 MAX. WATTS
GRID DISSIPATION	50 MAX. WATTS

TYPICAL OPERATION (Power input limited to 500 and 1000 watts)*

D-C Plate Voltage	2000	2000	2500	2500	Volts
D-C Plate Current	250	500	200	400	Ma.
Total Bias Voltage	-500	-500	-525	-550	Volts
Fixed Bias Voltage	-410	-275	-300	-300	Volts
Grid Resistor	3000	3000	12,500	5000	Ohms
D-C Grid Current	30	75	18	50	Ma.
Peak R-F Grid Input Voltage	615	690	620	715	Volts
Driving Power	18	52	11	36	Watts
Grid Dissipation	3	15	2	9	Watts
Plate Power Input	500	1000	500	1000	Watts
Plate Dissipation	90	190	75	170	Watts
Plate Power Output	410	810	425	830	Watts

*The figures are for convenience in obtaining a 500 or 1000 Watt carrier input per tube to the modulated amplifier. The output figures do not allow for circuit losses.

TYPICAL OPERATION*

D-C Plate Voltage	1500	2000	2500	Volts
D-C Plate Current	520	525	450	Ma.
Total Bias Voltage	-370	-500	-550	Volts
Fixed Bias Voltage	-160	-260	-440	Volts
Grid Resistor	2800	3000	2000	Ohms
D-C Grid Current	75	80	55	Ma.
Peak R-F Grid Input Voltage	545	695	720	Volts
Driving Power	41	55	40	Watts
Grid Dissipation	13	15	10	Watts
Plate Power Input	780	1050	1125	Watts
Plate Dissipation	200	200	200	Watts
Power Output	580	850	925	Watts

*The figures are for one tube operating at maximum plate dissipation as a plate modulated Class C amplifier. The output figures do not allow for circuit losses.

**RADIO FREQUENCY POWER AMPLIFIER
 AND OSCILLATOR**

Class-C Telegraphy or FM Telephony
 (Key-down conditions, per tube)

MAXIMUM RATINGS

D-C PLATE VOLTAGE	- - - -	3000 MAX. VOLTS
D-C PLATE CURRENT	- - - -	900 MAX. MA.
PLATE DISSIPATION	- - - -	300 MAX. WATTS
GRID DISSIPATION	- - - -	50 MAX. WATTS

► Indicates change from sheet dated 1-1-44

TYPICAL OPERATION*

D-C Plate Voltage	- - - -	1500	2000	3000	Volts
D-C Grid Voltage	- - - -	-250	-300	-400	Volts
D-C Plate Current	- - - -	665	600	500	Ma.
D-C Grid Current	- - - -	90	85	80	Ma.
Peak R-F Grid Input Voltage	- - - -	430	480	575	Volts
Driving Power (approx.)	- - - -	33	36	40	Watts
Grid Dissipation	- - - -	11	11	8	Watts
Plate Power Input	- - - -	1000	1200	1500	Watts
Plate Dissipation	- - - -	300	300	300	Watts
Plate Power Output	- - - -	700	900	1200	Watts

*The figures show actual measured tube performance, and do not allow for circuit losses.

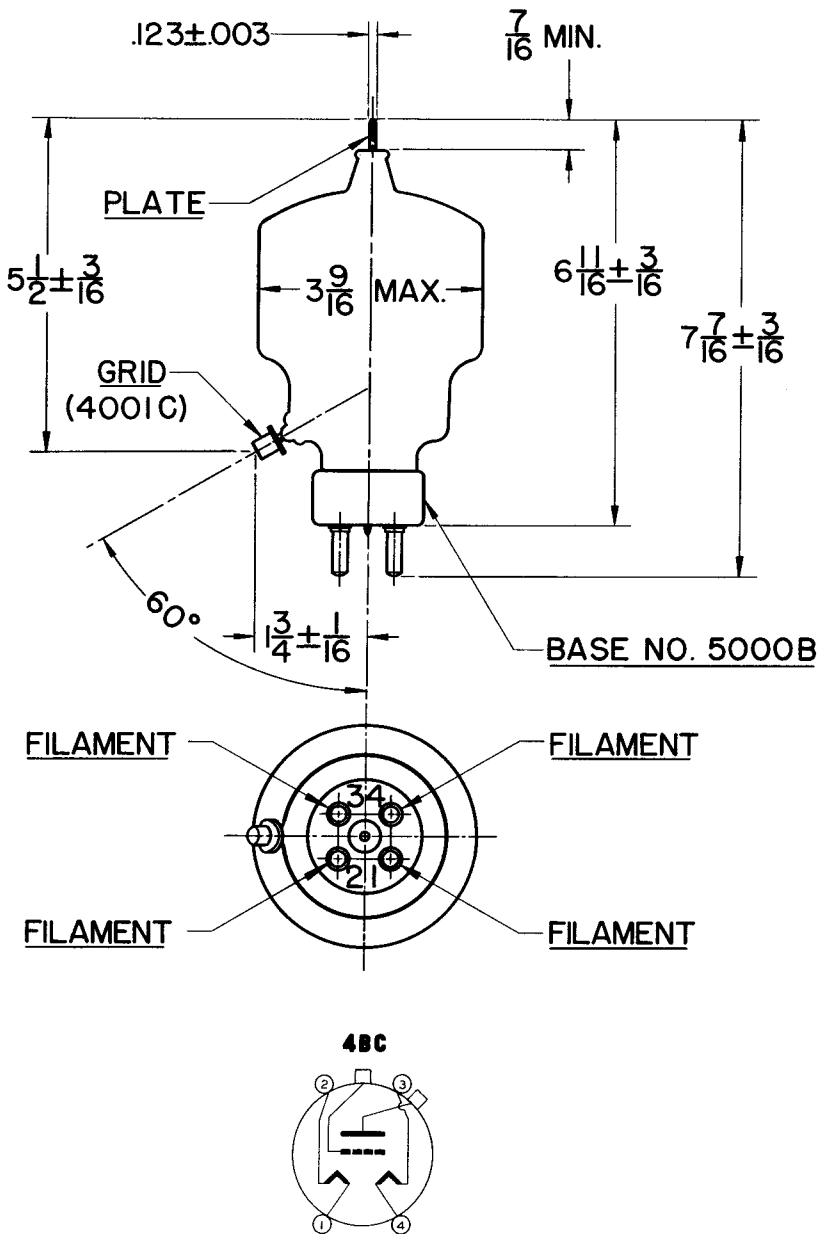

**GRID CAP
 NO. 4001C**

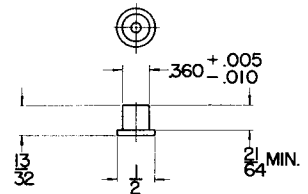

BASE NO. 5000B

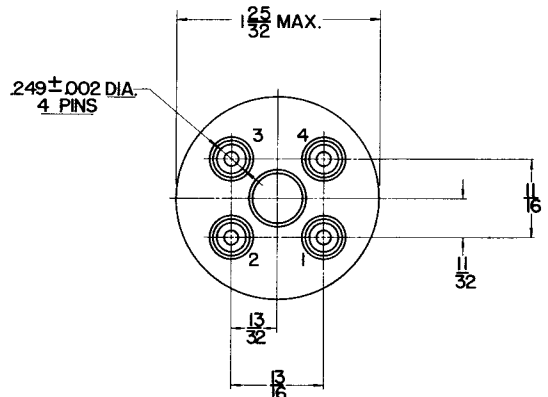
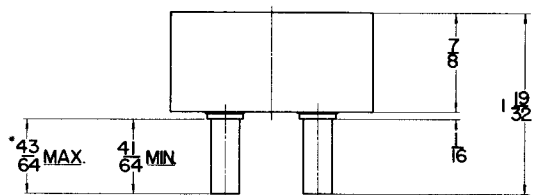

*ON FINISHED TUBE, ADD .060 FOR SOLDER

DRIVING POWER vs. POWER OUTPUT

The three charts on this page show the relationship of plate efficiency, power output and grid driving power at plate voltages of 1500, 2000 and 3000 volts. These charts show combined grid and bias losses only. The driving power and power output figures do not include circuit losses. The plate dissipation in watts is indicated by P_p .

Points A, B, and C are identical to the typical Class C operating conditions shown on the first page under 1500, 2000, and 3000 volts respectively.

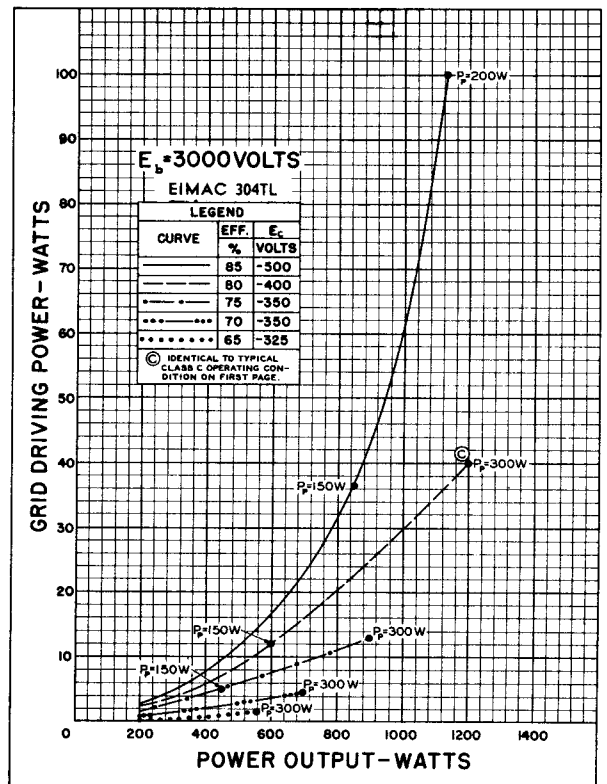
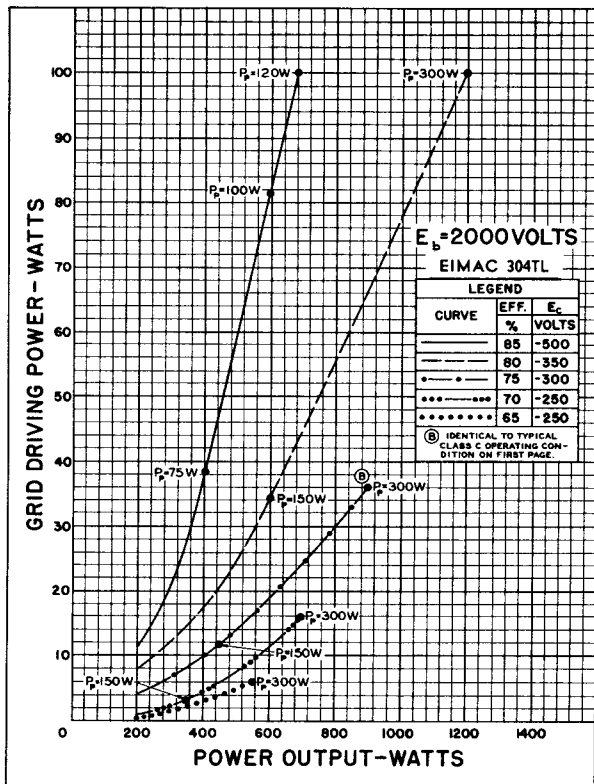
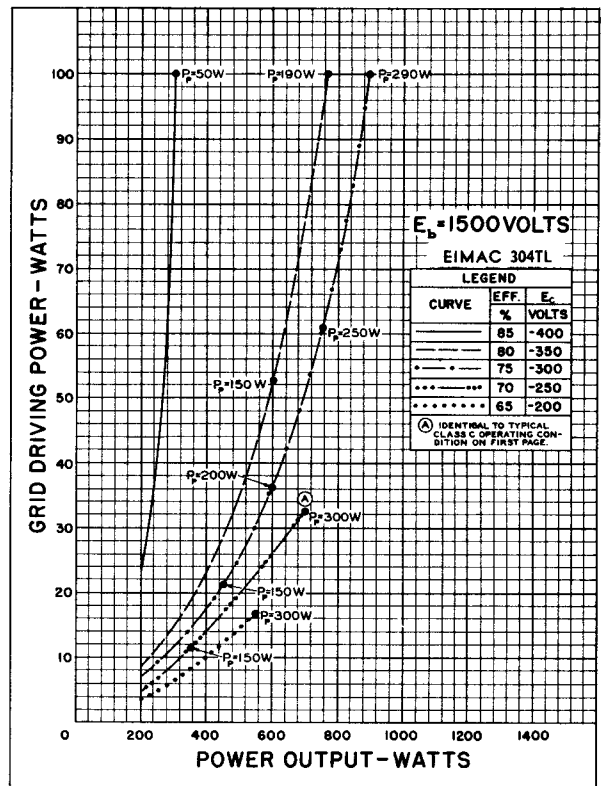

G R I D V O L T S

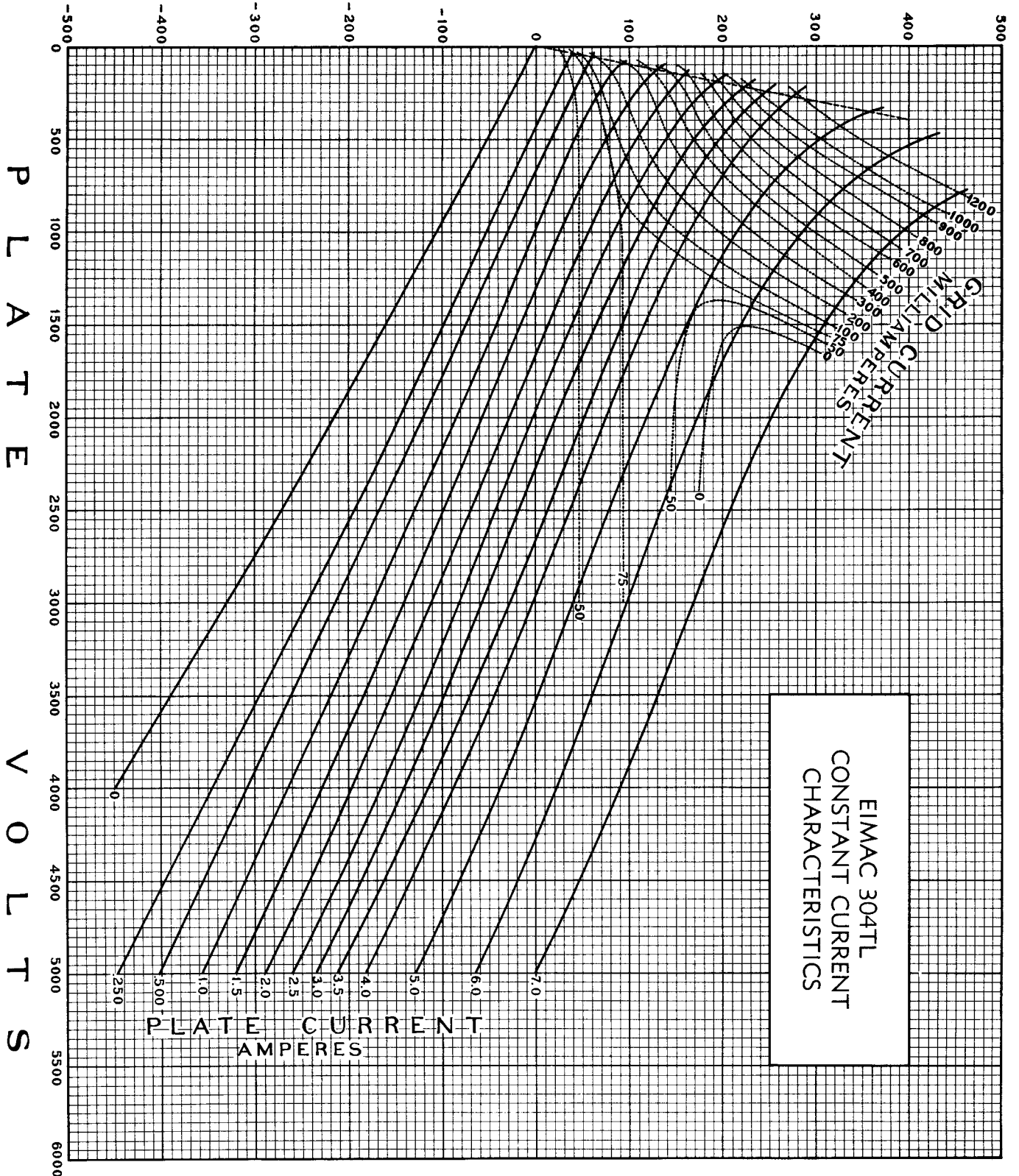

EIMAC 304TL
 CONSTANT CURRENT
 CHARACTERISTICS